

SOT-23 Plastic-Encapsulate MOSFETS

MMBT2222A TRANSISTOR (NPN)

MARKING :

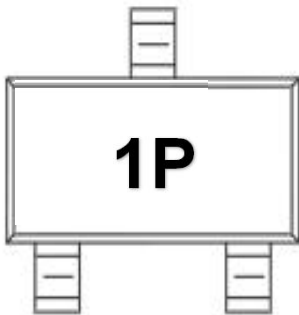

Equivalent Circuit :

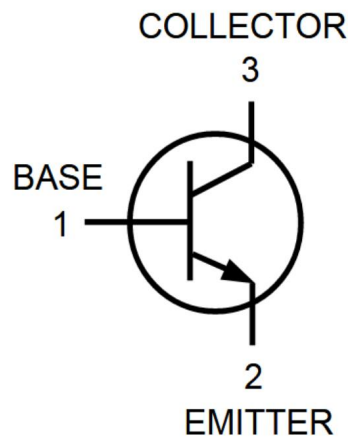

SOT-23

- 1.BASE
- 2.EMITTER
- 3.COLLECTOR

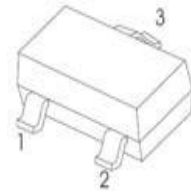

FEATURES:

- ※ Complementary PNP Type available MMBT2907A
- ※ Collector Current: $I_c=0.6A$
- ※ Epitaxial Planar die construction

MAXIMUM RATINGS ($T_a=25^{\circ}C$ unless otherwise noted)

Parameter	Symbol	Value	Unit
Collector-Base Voltage	VCBO	75	V
Collector-Emitter Voltage	VCEO	40	V
Emitter-Base Voltage	VEBO	6	V
Collector Current	IC	600	mA
Collector Power Dissipation	PC	300	mW
Thermal Resistance From Junction To Ambient	ROJA	417	$^{\circ}C/W$
Junction Temperature	Tj	150	$^{\circ}C$
Storage Temperature	Tstg	-55~+150	$^{\circ}C$

ELECTRICAL CHARACTERISTICS (Ta=25°C unless otherwise specified)

Parameter	Symbol	Test Condition	Min	Typ	Max	Unit
Collector-base breakdown voltage	V(BR)CBO	IC= 10μA, IE=0	75			V
Collector-emitter breakdown voltage	V(BR)CEO	IC= 10mA, IB=0	40			V
Emitter-base breakdown voltage	V(BR)EBO	IE=10μA, IC=0	6			V
Collector cut-off current	ICBO	VCE=60 V , IE=0			0.01	μA
Collector cut-off current	ICEX	VCE=30V , VBE(Off)=3V			0.01	μA
Emitter cut-off current	IEBO	VEB= 3V , IC=0			0.1	μA
DC current gain	hFE	VCE=10V, IC= 150mA	100		300	
	hFE	VCE=10V, IC= 0.1mA	40			
Collector-emitter saturation voltage	VCE(sat)	IC=500 mA, IB= 50mA			1	V
		IC=150 mA, IB= 15mA			0.3	V
Base-emitter saturation voltage	VBE(sat)	IC=500 mA, IB= 50mA			2.0	V
		IC=150 mA, IB= 15mA			1.2	V
Transition frequency	fT	VCE=20V, IC= 20mA f=100MHz	300			MHz
Delay time	td	VCC=30V, Ic=150mA, IB1=15mA,			10	ns
Rise time	tr				25	ns
Storage time	ts	VCC=30V, Ic=150mA, IB1=15mA,			225	ns
Fall time	tf				60	ns

CLASSIFICATION OF hFE

Rank	L	H
Range	100-200	200-300

TYPICAL ELECTRICAL AND THERMAL CHARACTERISTICS

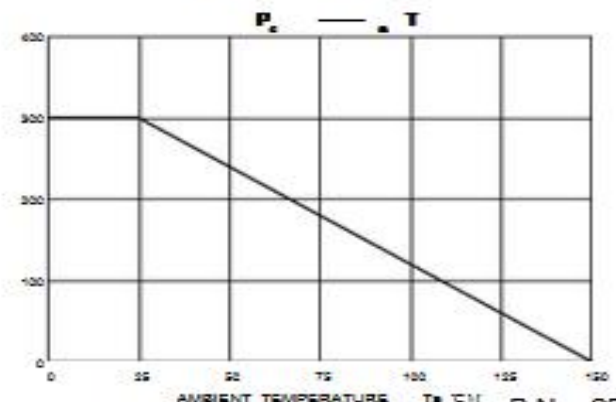
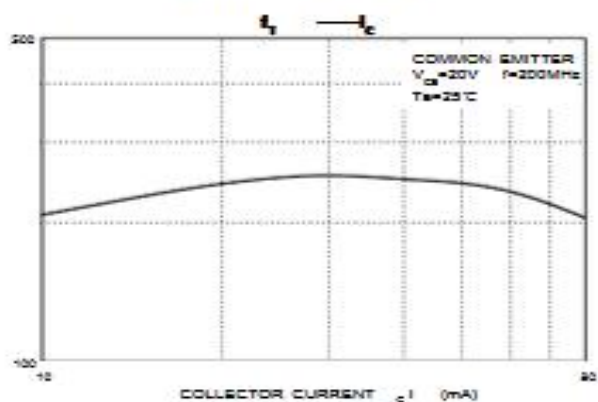
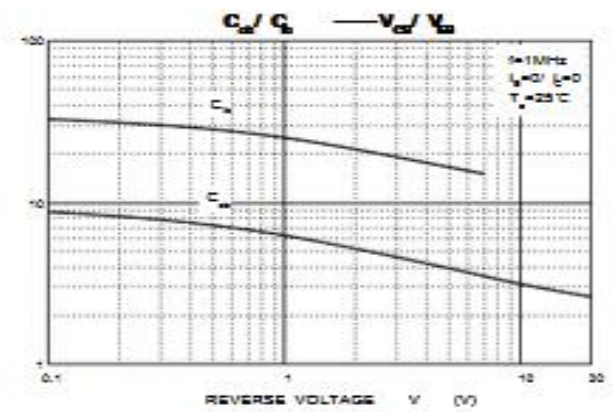
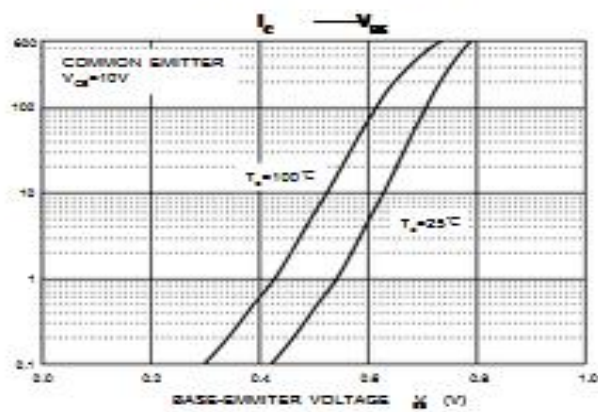
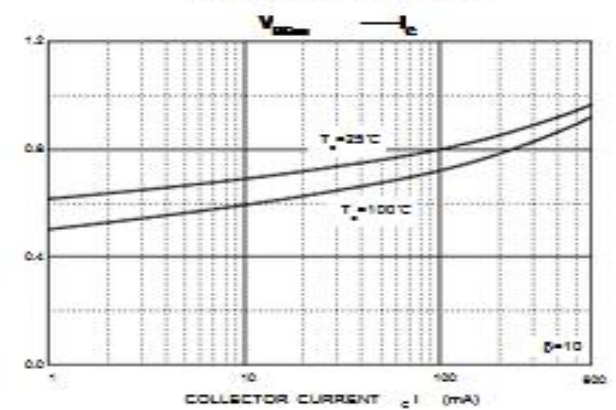
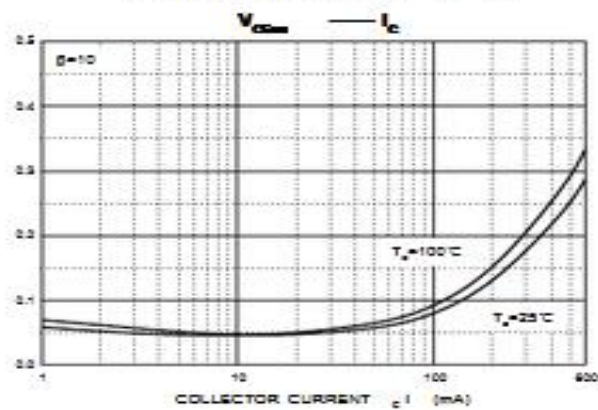
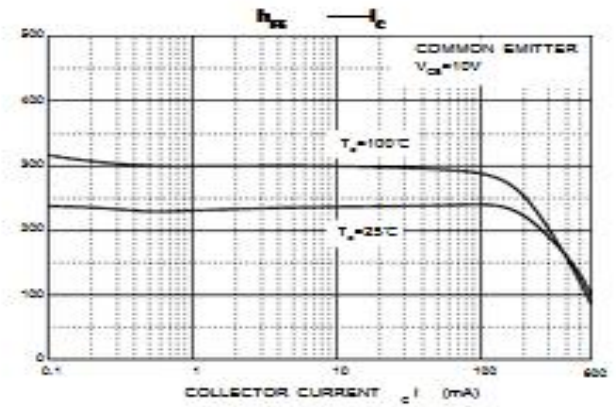
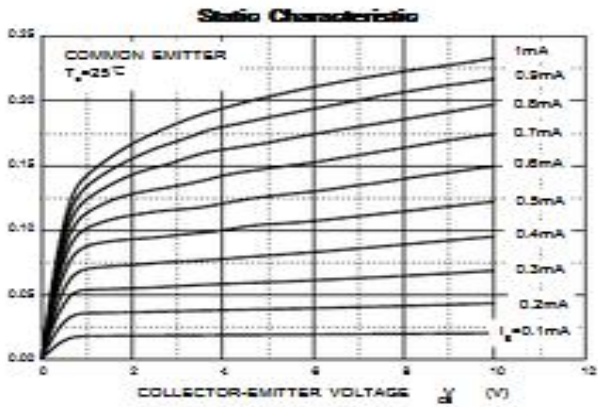

B, Nov, 2011

SOT-23 PACKAGE OUTLINE DIMENSIONS

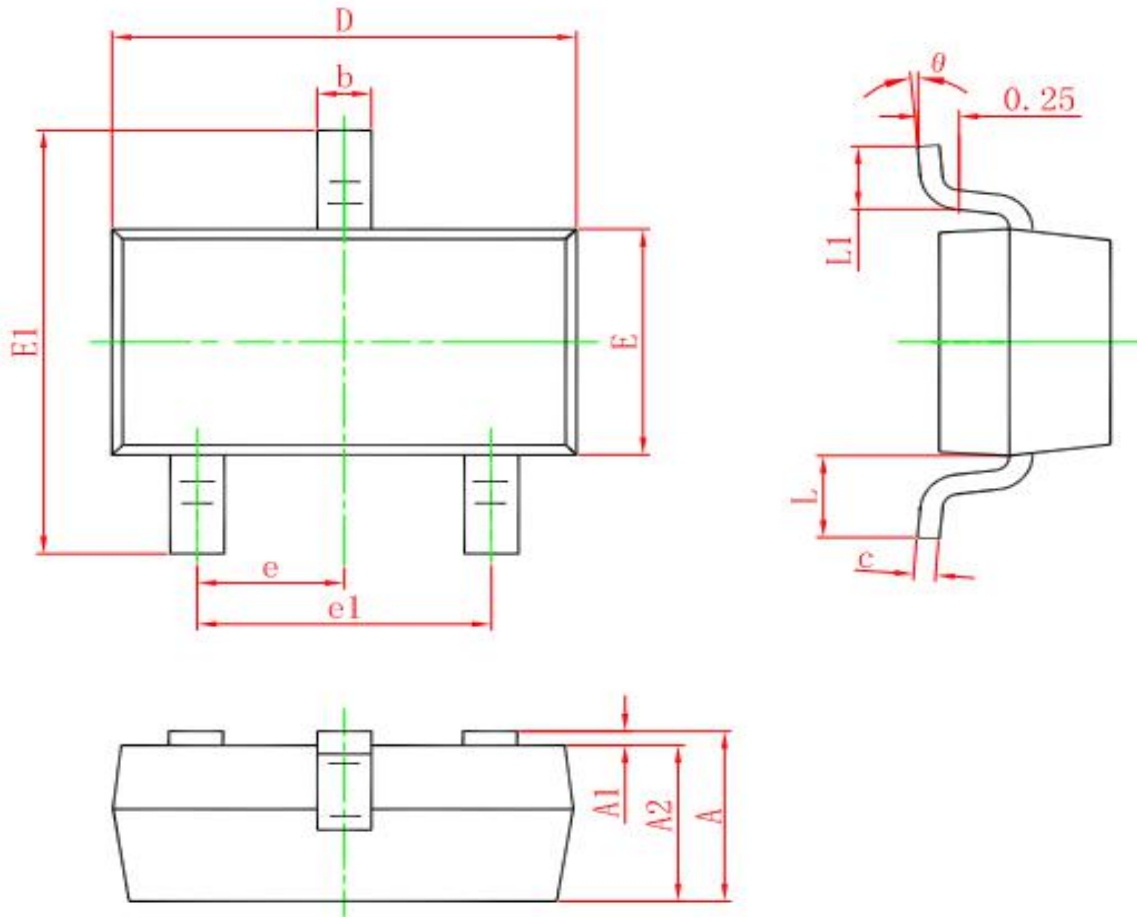

Symbol	Dimensions In Millimeters		Dimensions In Inches	
	Min.	Max.	Min.	Max.
A	0.900	1.150	0.035	0.045
A1	0.000	0.100	0.000	0.004
A2	0.900	1.050	0.035	0.041
b	0.300	0.500	0.012	0.020
c	0.080	0.150	0.003	0.006
D	2.800	3.000	0.110	0.118
E	1.200	1.400	0.047	0.055
E1	2.250	2.550	0.089	0.100
e	0.950 TYP.		0.037 TYP.	
e1	1.800	2.000	0.071	0.079
L	0.550 REF.		0.022 REF.	
L1	0.300	0.500	0.012	0.020
θ	0°	8°	0°	8°